

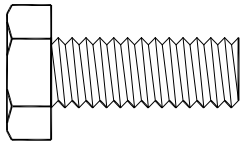

Quantum QS-000 Standard hardware - Drawn actual size REV4 Frame

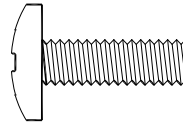

3/8"x1" Bolt  
8-pcs



1/4"x3/4" Machine screw  
4-pcs

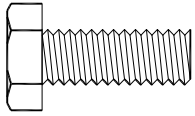

5/16"x3/4" Bolt  
8-pcs

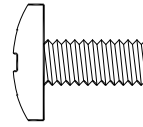

1/4"x1/2" Machine screw  
4 pcs

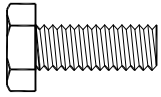

1/4"x5/8" Bolt  
16-pcs

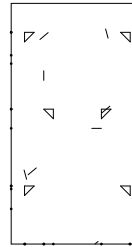

Rubber Bumper  
(adhere to side of Top Roller)  
4-pcs

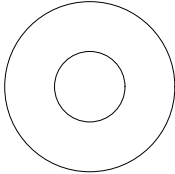

Plate washer for 3/8"  
8-pcs

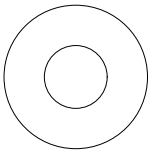

Plate washer for 5/16"  
8-pcs



1/4" Regular nut  
8-pcs

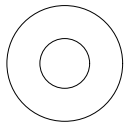
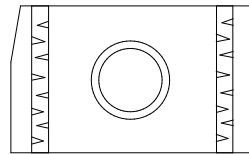
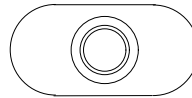

Plate washer for 1/4"  
20-pcs



3/8" Strut nut  
8-pcs

Tip-Out Bin Fastening Hdw. Bulk Bagged



1/4" Tab/channel nuts  
170-pcs

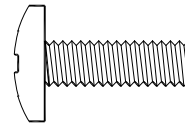

1/4"x3/4" Machine screw  
170-pcs

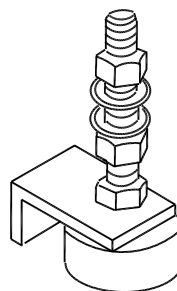

Bottom roller assy.  
4-pcs  
(not to scale)

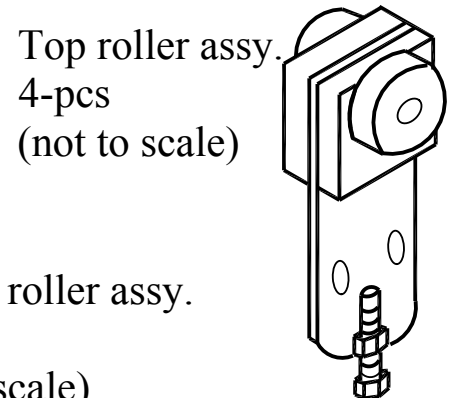

Top roller assy.  
4-pcs  
(not to scale)